

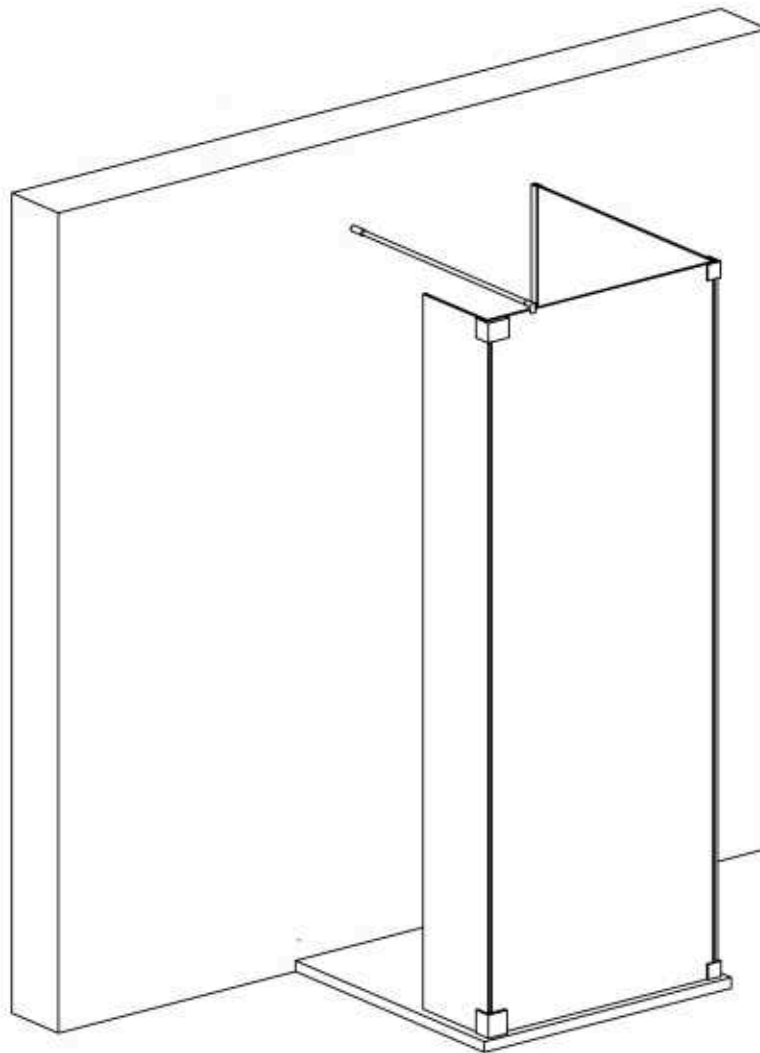















Modell

PGUWO, PHUWO, PMGUWO

Montageanleitung
Installation Manual



3-Seiten U-Duschkabine
U-shaped shower enclosure
Rechts / Right

- | | | | | | | | | |
|-----------|---|--------------|---|----------|---|---|---|---|
| 4 x G/EL |  | 2 x G9/G9H |  | 8 x G100 |  | 4 x  5x60 | 6 x C2 |  |
| 1 x P/WKP |  | 1 x G13/G13H |  | 8 x G300 |  | 4 x  8x50 | 1 x G/SUL120 |  |
| | | | | 4 x d |  | 8 x  M6x12 | 2 x  | |
| | | | | | | 1 x  | 1 x  | |

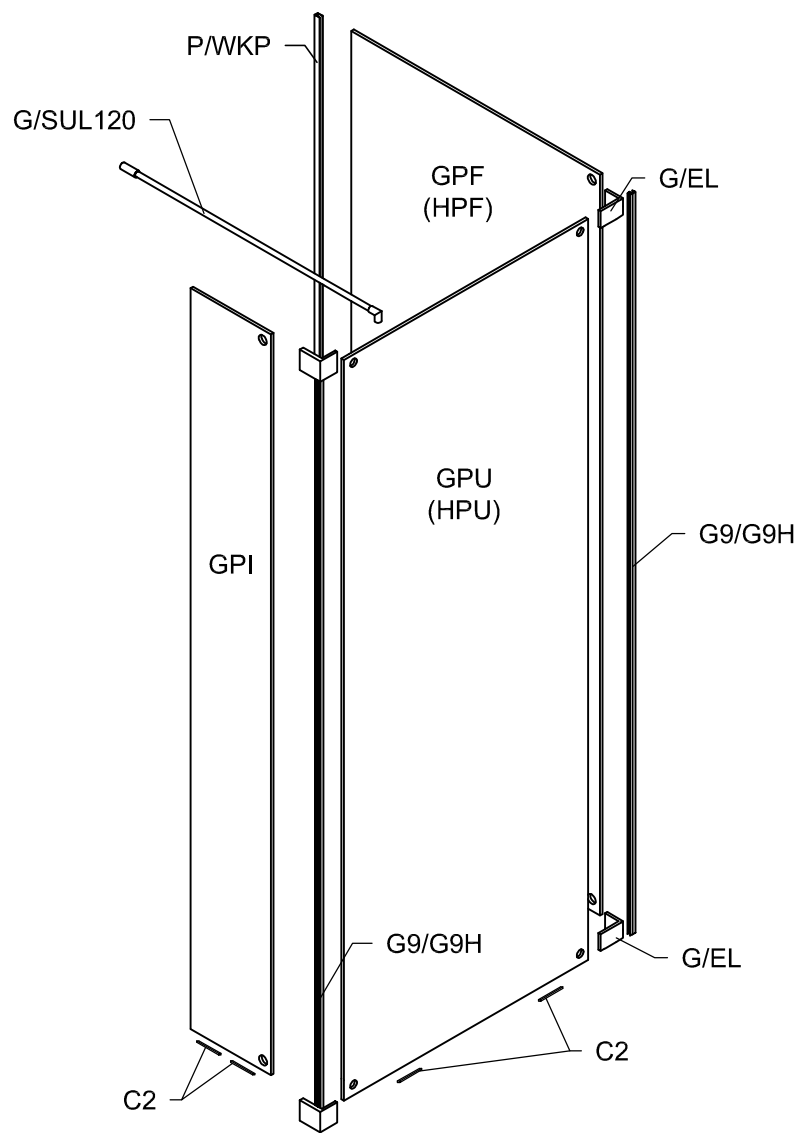

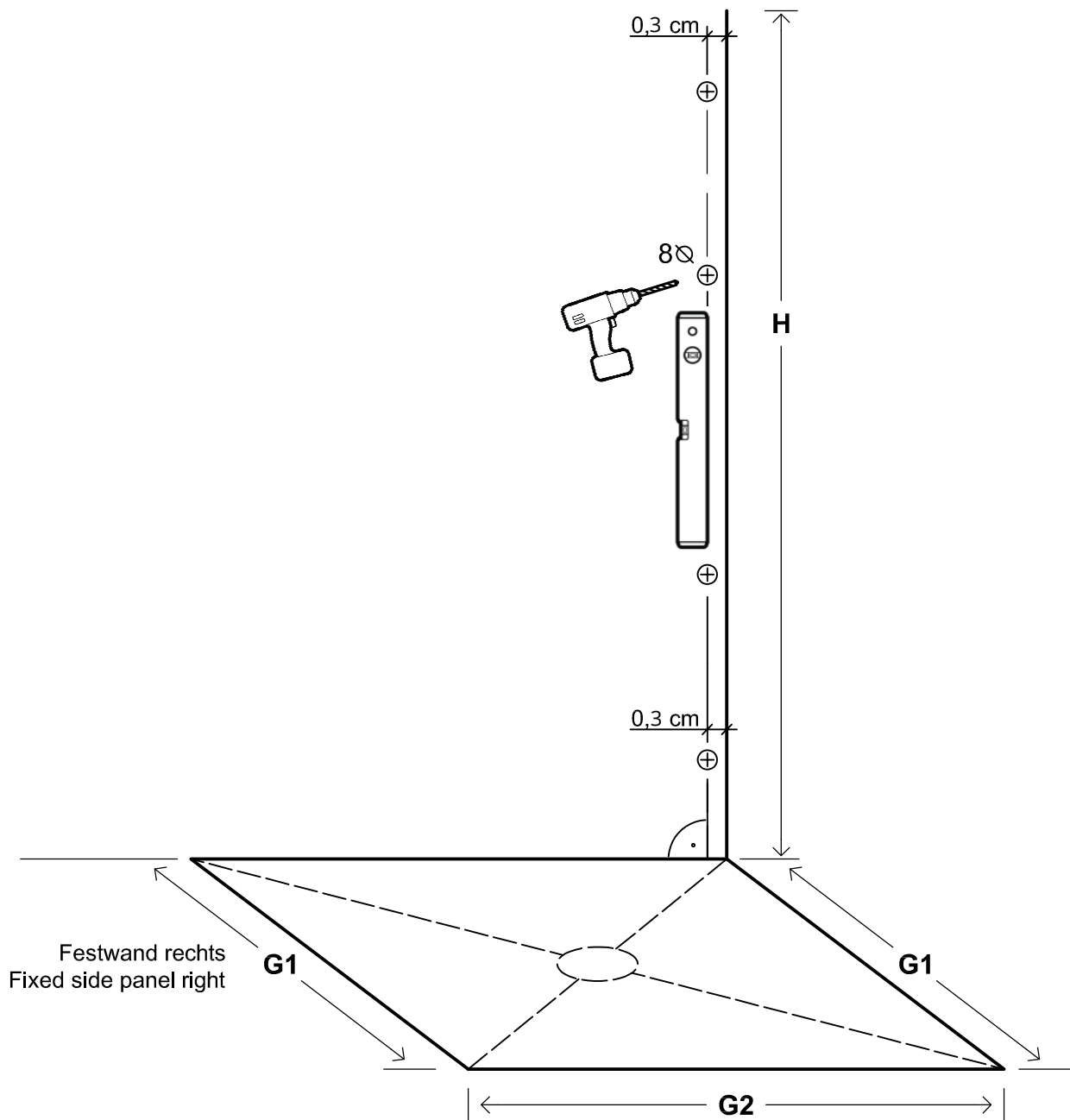

Diese Maße finden Sie in ihrem Auftrag:
You find this measures in your order:

H = Glas - Höhe
Glass height

G1, G2 = Glasaußenkante (unterer Wert des Verstellbereichs)
Outer edge of the glass (lower value of adjustment range)

Die Zeichnungen sind **nicht** Maßstabsgetreu.
The drawings are **not** to scale.

Vormontage von Dichtprofilen und Beschlägen Pre-assembly of gaskets and fittings.

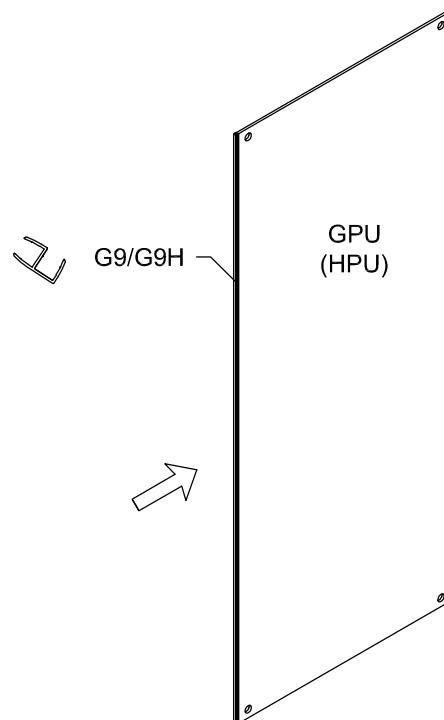
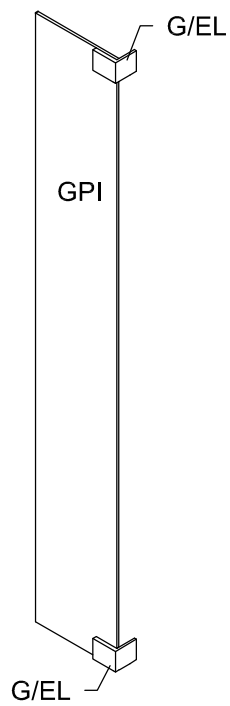
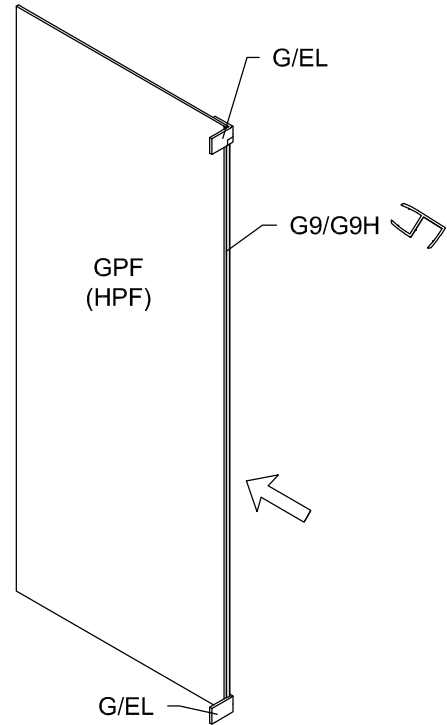

Wieder öffnen:
Open again:
Per riaprire:
Ouvrir à nouveau:

